



# Battery Electric Bus Familiarization

Module 3:

**Battery Charging Technologies**



# Overview

Overview

Charging Overview









Electric Vehicle Charging Standards

Details of Charging Technologies

Brief Charging Precautions

Summary

# Learning Outcomes

-  **DESCRIBE THE THREE PRIMARY CHARGING METHODS FOR BEBS**
-  **CALCULATE AN ANTICIPATED CHARGE TIME FOR EACH METHOD OF CHARGING**
-  **EXPLAIN THE GENERAL PROCESS OF HOW A CHARGER AND BATTERY COMMUNICATE**
-  **IDENTIFY THE PURPOSE OF A SWITCHGEAR**
-  **DEFINE SMART CHARGING**
-  **EXPLAIN THE PURPOSES OF SAE J1772, SAE J3105 AND SAE J2945-2**
-  **LIST AT LEAST 3 OPPORTUNITIES FOR EMERGING CHARGING TECHNOLOGIES**
-  **DESCRIBE SAFETY PRECAUTIONS FOR CHARGING EQUIPMENT**

# Overview

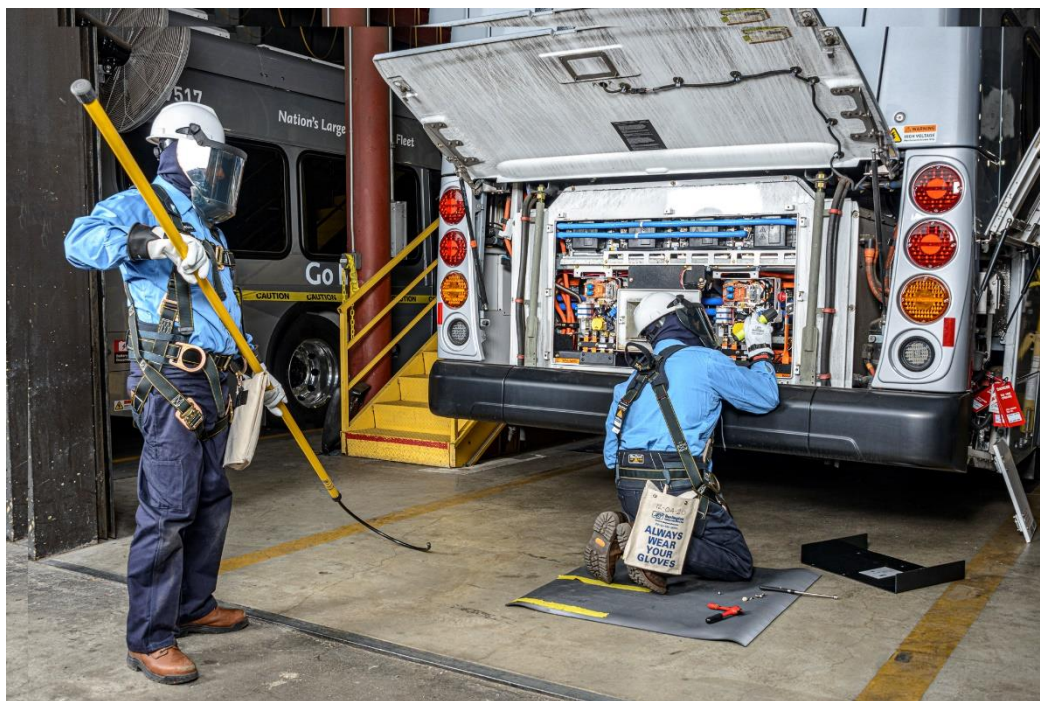

*A quick note to participants: Not every agency will have the same bus manufacturer or model as demonstrated in this course. Please consult your manufacturer's manual and agency's specific guidelines when it comes to working with a BEB. Each agency may have a variation of names for a specific tool and can vary from agency to agency.*



# Overview

AC- Alternating Current	BMS- Battery Management System	AC Charger- Inverter on vehicle
CCS- Combined Charging System	Conductive Charging	DC-Direct Current
DCFC – DC Fast Charging	Depot Charging	ESS- Energy Storage System
EVSE – Electric vehicle supply equipment	Inductive Charging	Kw- Kilo-watt
kWh- kilo-watt hour	Opportunity/On-route charging	Overnight Charging
Smart Charging		



# Section 3-2: Charging Overview



# Various Charging Options (91)

## Transit Bus Charger Suppliers





# Various Charging Options (91)

## Charging Options

### Plug-In (DC)

Charging with a unit at the depot/agency

Can be pedestal or wall-mounted, typically charge quicker

### Overhead DC Charger

Has inverter in the (DC) converter, so needs a bigger cabinet and more expensive

Trade off of faster charge and less time





# Various Charging Options (92)

## Charging Options

### Overhead

Done via with roof-mounted pantograph charging system  
Pantograph-up or pantograph-down styles; usually requires less battery capacity since charging occurs on route



### Inductive

Done via electromagnetic induction; technology is wireless charging station in the ground (as a pad) with pads on the bus to collect energy



## Charging Times (93)

$$\text{Charging Time [h]} = \text{Battery Capacity [kWh]} / \text{Effective Charging Power [kW]}$$

Keep in mind – other factors may influence charging time:

- Heat
- Energy demands
- Pre-conditioning (cold temperatures) and wear
- Battery chemistry

## Charging Times (93)

**Charging Time [h] = Battery Capacity [kWh] / Effective Charging Power [kW]**

AC Depot Plug In Charger (80kW) = 320kWh/80kW

DCFC Depot Plug In Charger (150kW) = 320kWh/150kW

Pantograph Charger (300kW) = 320kWh/300kW

# Learning Application 3A

1. An AC Charger with a battery capacity of 240 kWh and an effective charging power of 60kW =
2. A DC charger with a battery capacity of 400 kWh and an effective charging power of 50 kW =
3. Pantograph or overhead charger with a battery capacity of 400 kWh and an effective charging power of 100Kw =
4. Wireless charging battery capacity at 360kWh and an effective charging power of 120kW =

# Section 3-3: Electric Vehicle Charging Standards

# Electric Vehicle Charging Standards (95)

## SAE J1772 –

Standard for plug in chargers (most common depot application for North America)

## SAE J3068 –

More to do with AC charging and not as applicable



## SAE J3105 –

Covers Overhead charging, applies to conductive or pantograph charging

## SAE J2954-2 –

Covers inductive charging (contactless)

# Electric Vehicle Charging Standards (95)

## SAE J1772 –

Describes the electrical and physical interfaces between vehicle and supply equipment to facilitate conductive charging in plug-in configurations

Covers AC and DC charging capabilities (mostly DC for transit operations and heavy-duty vehicles)

DC applications can cover between 80 kilowatts and 400 kilowatts

Includes several levels of shock protection (in case of wet conditions)

Connection pins are isolated on interior of connection when mated, ensuring no physical access

- When not mated, connectors have no power voltages at pins and charging power does not flow until commanded

If plugged in while charging and suddenly removed, shorter control pilot pin breaks first, causing power relay to open and stops flow

# Electric Vehicle Charging Standards (96)

Two options common in the industry:

1. Roof-mounted pantograph [“bus-up”]
2. Inverted pantograph [“bus-down”]

Allows for on-route & depot charging at higher charge capacities (currently up to about 600 kilowatts)

Infrastructure allows for installation of more powerful chargers for faster charge times

These typically allow for connection & charging of battery in shorter time frame; can be utilized on revenue service route(s) or at agency

SAE J3105 –



Roof mounted



Inverted



# Electric Vehicle Charging Standards (97)

Allows for on-route and depot charging

Windings built into roads generate electromagnetic fields; interact with a receiver built into the bus floor which converts the EM energy into energy to charge ESS

- Similar process to modern cell phone charging; transit operations require higher duty cycles and more efficient

Will not come into contact with HV when handling inductive charge tech

If windings fail at any point, circuit is disconnected; this is due to it existing below the asphalt

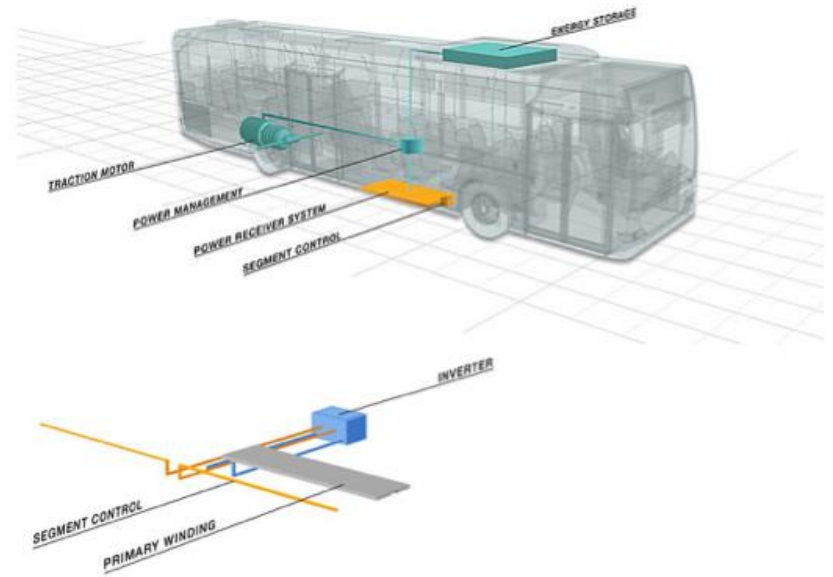

**SAE J2954-2 –**

# Knowledge Check [MC]

Choose the correct answer(s). Given a bus with a battery capacity of 360kWh and an effective charging power of 120 kW, what is the anticipated charge time?

A) 4.6 Hours

B) 3 Hours

C) 4 hours

D) 3.6 Hours

# Section 3-4: Details of Charging Technologies

# Battery and Charger Communications (98)

## Battery Management System [BMS] – Battery/Charger Communication Cycle

1. Ground sensing circuit is built into both vehicle charge port and **charge cable**
2. Vehicle and charger share information on: **operating voltages**, SOC , charger capabilities, **charge parameters** of vehicle and current status of HV systems
3. Charger and vehicle perform an **isolation test** (failure aborts charge sequence)
4. Powertrain is automatically disabled once sensing circuit is active; Once handshake is initiated a “**powertrain inhibit**” signal sent to powertrain controller to keep vehicle from driving away

## Battery and Charger Communications (98)

### Battery Management System [BMS] – Battery/Charger Communication Cycle

5. **Control pilot** functions begin (when the supply equipment detects the BEB). Supply equipment indicates readiness and whether or not it's able to supply the energy.
6. Ventilation and cooling requirements are determined by the charger. Then the **supply equipment current capacity** is provided to BEB.
7. After the tests pass the vehicle signals the charger to begin charging (charge controller on vehicle **always** has final control of charge sequence)
  - a) Contactors in the charger close and charger supplies current to vehicle
  - b) Charge contactors on vehicle close and allow charger to supply charge current

# Battery and Charger Communications (98-99)

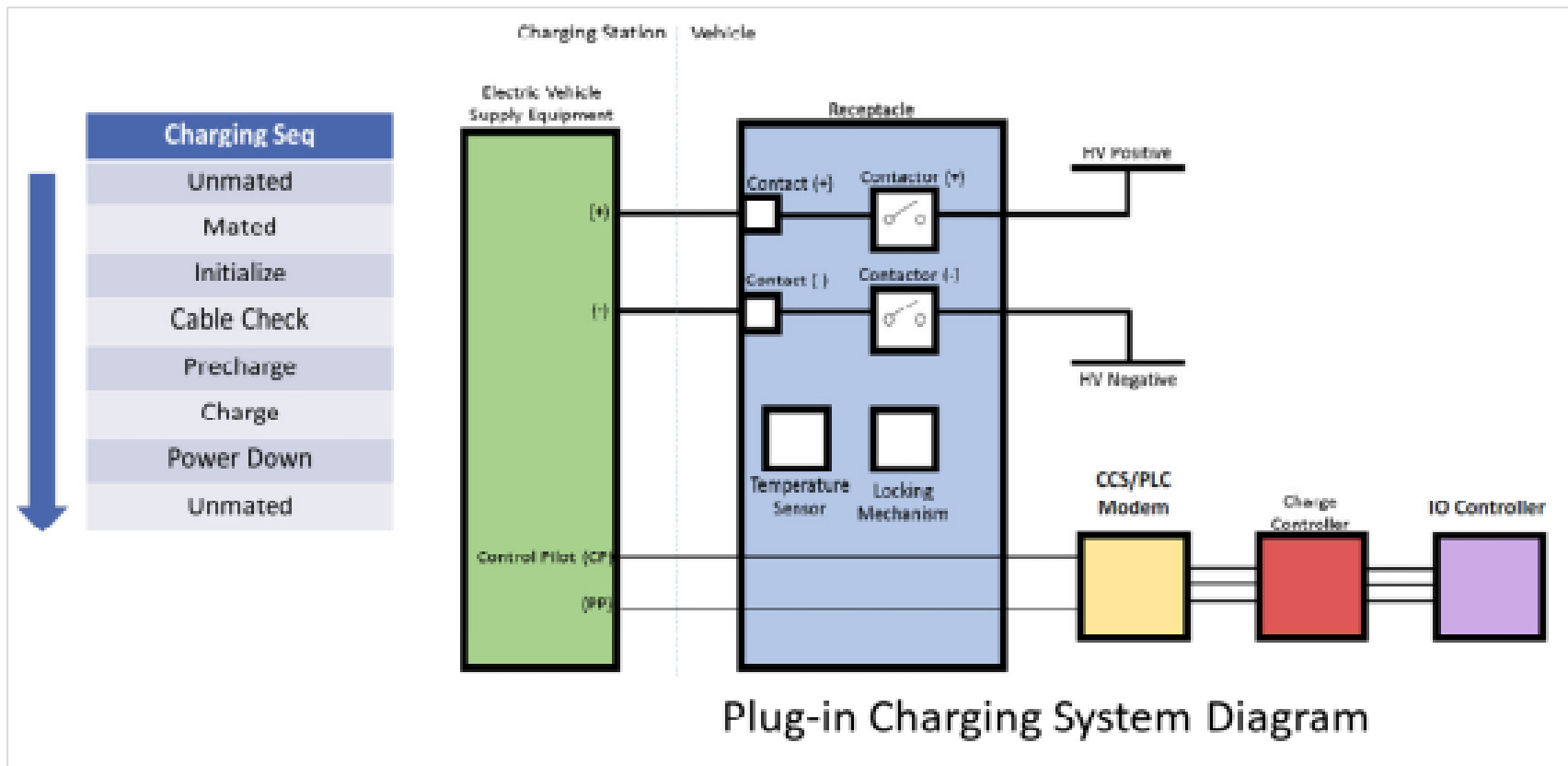

**Until communication process, no HV is present at charge cable**

- HV isolation continuously monitored during charging
- Sequence automatically ends if any parameter exceeds limits

# Battery and Charger Communications (99)

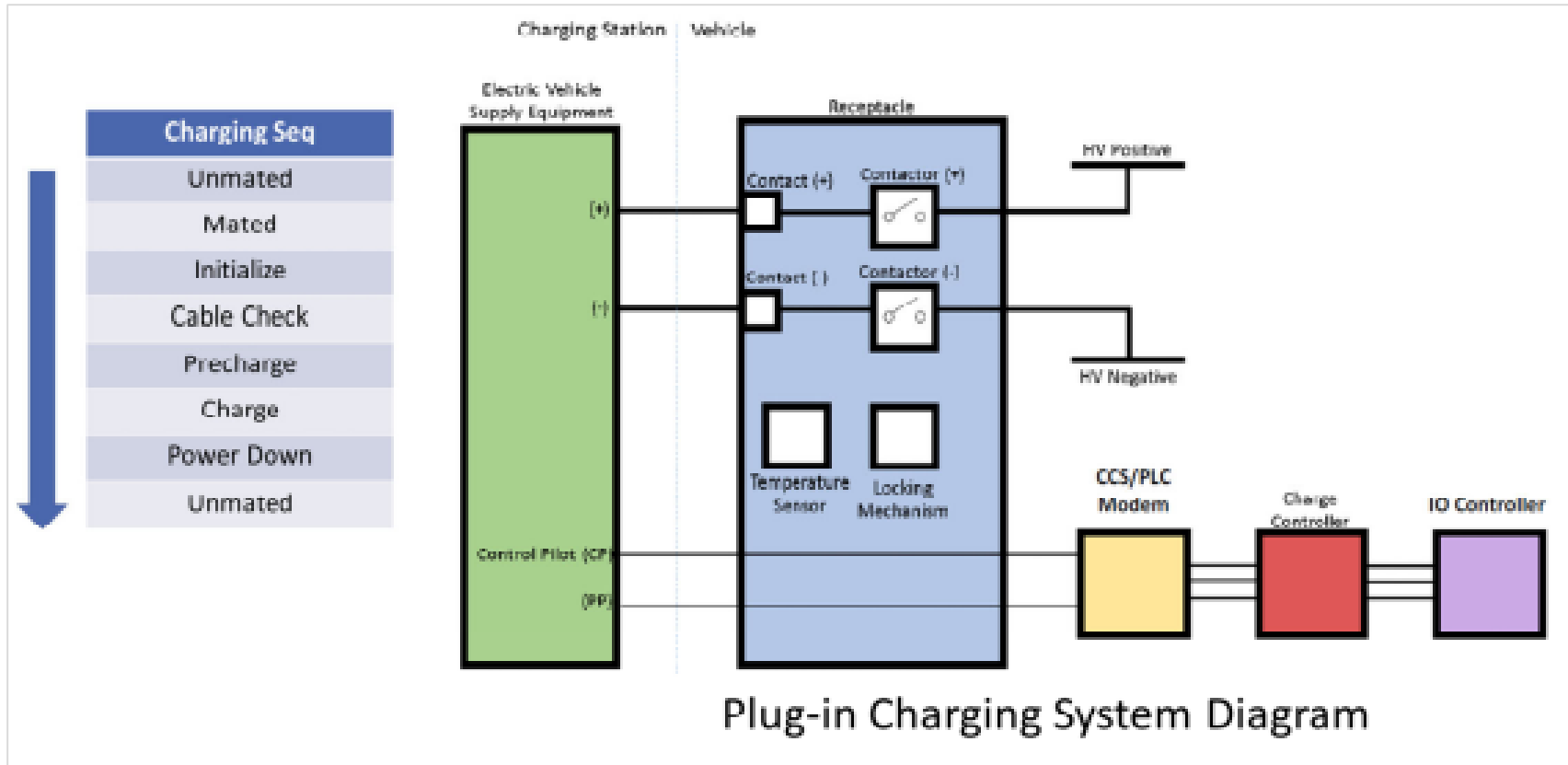

Looking for isolation breakdown

If the HV circuit comes into contact with anything other than its own circuit

During entire charge process, the bus is controlling command charge

# Knowledge Check [True/False]

Standard J1772 describes the electrical and physical interfaces between the vehicle and supply equipment to facilitate conductive charging in a plug-in configuration.

TRUE



FALSE



# Knowledge Check [True/False]

Standard J2954-2 describes the method of depot charging utilizing smart charging capabilities.

TRUE



FALSE



# AT-BUS DEMONSTRATION – Connect/Disconnect Charge Plug into Bus

# Transformers and Switchgears (99)

**Transformer** – device that transfers electrical energy from one electrical circuit to another (or multiple) while increasing, decreasing or maintaining same voltage (but can't transform DC)

- Can be pole-mounted, in a cabinet, at transit depot, or where charging equipment is
- Usually along with a meter that utility company sets up
- Lenz's Law applies
- Have utility company involved with long-term infrastructure planning

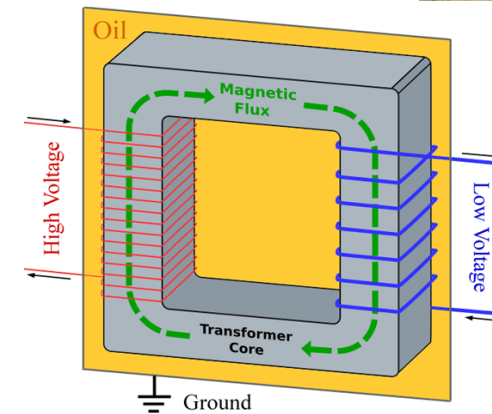

# Transformers and Switchgears (100)

**Switchgear** – device in an electrical system made up of electrical disconnect switches, fuses and/or circuit breakers to monitor, control, protect and isolate electrical equipment in a surge event

- Can be an individual switch to dis/connect grid voltage from a circuit, series of switches, fuses or circuit breakers
- If triggered, automatically interrupts power flow to protect electrical systems from damage
- Allows for energizing/de-energizing of charging equipment safely



# Emerging Charging Technologies (101)

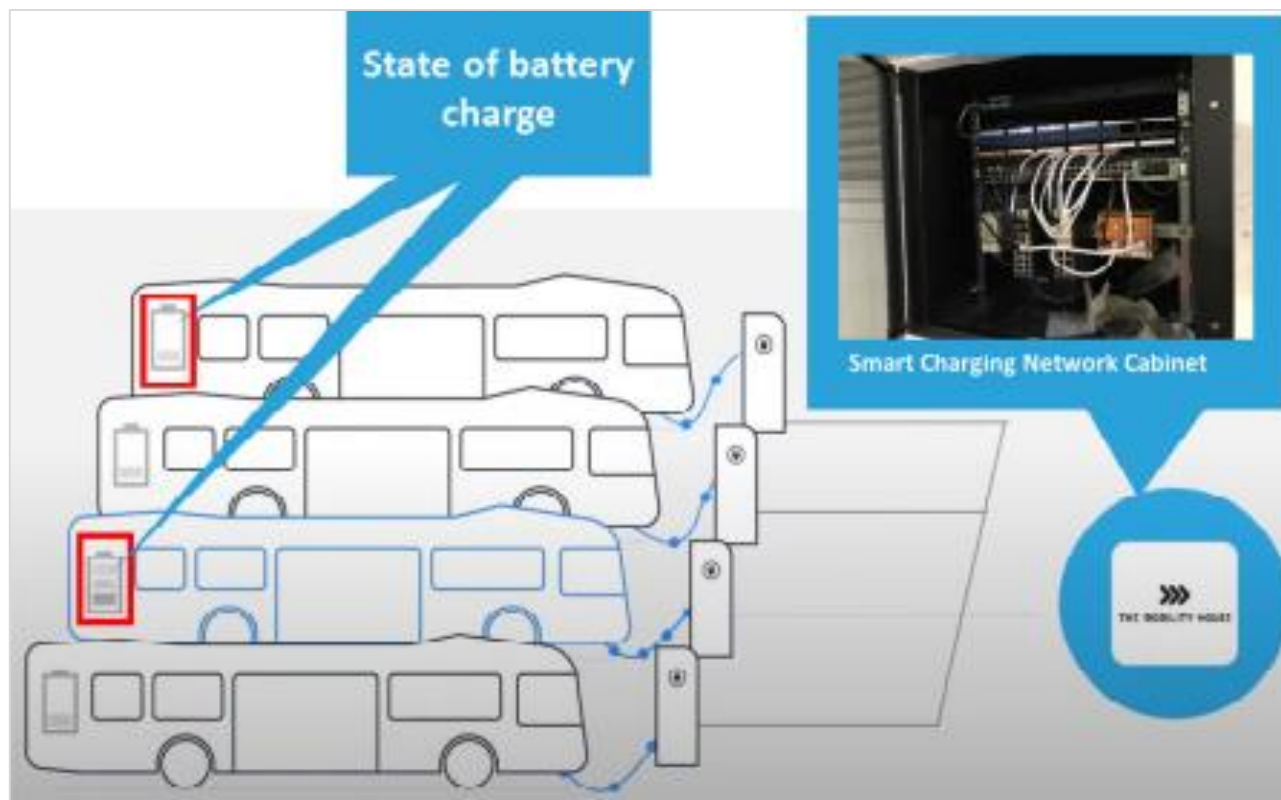

## Smart Charging

- Ensures that all vehicles are charged.
- Limits peak demand charges based on software parameters.
- Prioritizes specific vehicles.
- Reports charging data and vehicle status.
- Provides alerts in case of charge failure

# Emerging Charging Technologies (102)

## Simultaneous vs. Sequential Charging

- Simultaneous may have two or more vehicles connected at once
  - One charger can have multiple connections to a bus
  - Charges all vehicles connected to the charger at the same rate
- Sequential prioritizes one vehicle at a time
  - Dependent on when vehicle comes into depot or vehicle with lowest state of charge [SOC]
  - One charger prioritizes one battery at a given moment

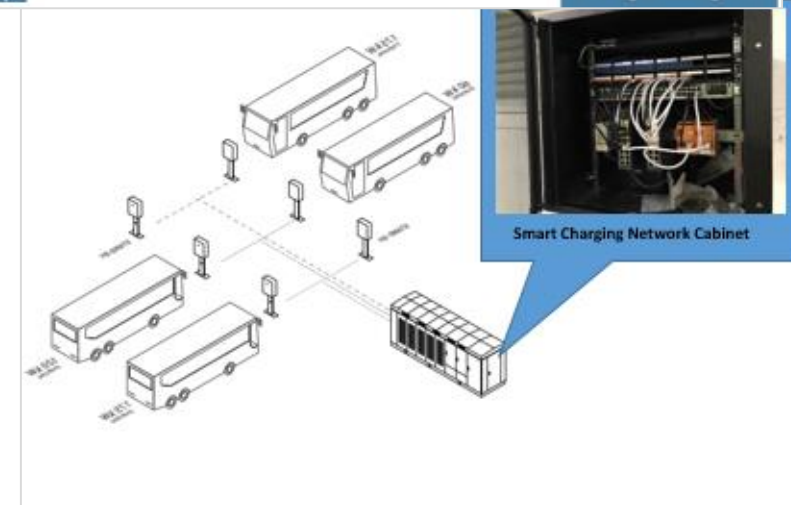



# Emerging Charging Technologies (103)

## Other Emerging Charging Technologies & Opportunities

- Some locations repurposing existing overhead cabling as used by electric trolleys
- Solar panels on bus roofs to offset/assist electric demands from HVAC system
- Vehicle-to-grid (V2G) for emergency power (to help with peak demand)
- Wireless electrified roads
- Remote wireless charging
- Solid-state batteries (improve battery and lifespan)
- Ultra-fast carbon electrode technology
- Semi-conductors, ultra-fast charging & nanowire battery technology

# Learning Application 3C

1. First off, a ground sensing circuit is built into both the vehicle charge port and the \_\_\_\_\_.
2. Vehicle and charger share information on: \_\_\_\_\_, SOC (state of charge), charger capabilities (output), \_\_\_\_\_ of vehicle (max current and for how long), and current status of HV systems (faults).
3. Charger and vehicle perform an \_\_\_\_\_ (failure of this test aborts charge sequence)
4. The powertrain is then automatically disabled once this sensing circuit is active. Once the handshake is initiated, a “\_\_\_\_\_” signal is sent to the powertrain controller to keep the vehicle from driving away.
5. Then the \_\_\_\_\_ functions begin – this is when the supply equipment detects the BEB – the supply equipment then indicates exactly its readiness and whether or not it’s able to supply the energy.
6. The BEB ventilation and cooling requirements are determined, which is an important thing that both the bus and charger need to understand. Then the \_\_\_\_\_ is provided to BEB.
7. After the tests pass the vehicle signals the charger to begin charging (charge controller on vehicle **always** has final control of charge sequence
  - a. \_\_\_\_\_ in the charger close and charger supplies current to vehicle
  - b. Charge contactors on \_\_\_\_\_ close and allow charger to supply charge current

Word Bank: Charge cable, operating voltages, charge parameters, isolation test, “powertrain inhibitor”, control pilot, supply equipment current capacity, contactors, vehicle



# Learning Application 3C

1. First off, a ground sensing circuit is built into both the vehicle charge port and the `_charge cable_`.
2. Vehicle and charger share information on: `_operating voltages_`, SOC (state of charge), charger capabilities (output), `_charge parameters_` of vehicle (max current and for how long), and current status of HV systems (faults).
3. Charger and vehicle perform an `_isolation test_` (failure of this test aborts charge sequence)
4. The powertrain is then automatically disabled once sensing circuit is active. Once handshake is initiated, a `"_powertrain inhibit_"` signal is sent to powertrain controller to keep vehicle from driving away.
5. Then the `_control pilot_` functions begin – this is when the supply equipment detects the BEB – the supply equipment then indicates exactly its readiness and whether or not it's able to supply the energy.
6. The BEB ventilation and cooling requirements are determined, which is an important thing that both the bus and charger need to understand. Then the `_supply equipment current capacity_` is provided to BEB.
7. After the tests pass the vehicle signals the charger to begin charging (charge controller on vehicle **always** has final control of charge sequence
  - a. `_Contactors_` in the charger close and charger supplies current to vehicle
  - b. Charge contactors on `_vehicle_` close and allow charger to supply charge current

Word Bank: Charge cable, operating voltages, charge parameters, isolation test, "powertrain inhibitor", control pilot, supply equipment current capacity, contactors, vehicle

# Section 3-5: Brief Charging Precautions

# Charger Safety Precautions (105)

## Some safety precautions:

- Disconnect all input and output sources; Use proper caution before opening or working on any equipment
- DC link capacitors can hold a charge after being disconnected from the grid & DC input
  - Make sure to wait proper time limit from OEM to verify no charge
- Remove any accessories and jewelry (watches, rings, metal objects) – Don't give power an easy current to ground through you
- Be sure all electrical connections and connectors are installed and properly torqued

# Charger Safety Precautions (106)

## Having a safety observer

### Wear your PPE!

- Arc flash suit, arc flash face shield with hard hat
- Balaclava or arc flash hood
- Safety glasses and earplugs/inserts
- Rubber insulated gloves (leather overlay) and EH rated safety shoes

### Keep tools/components on hand:

- Appropriately rated digital multimeter
- Lockout/Tagout devices
- Replacement tools like breakers for switchgear (charger and dispenser)
- *Multiple* charge cables
- Anti-static wrist strap

# Knowledge Check [True/False]

The purpose of a switchgear is to transfer electrical energy from one electrical (AC) circuit to another circuit (even multiple) while either increasing or decreasing voltage.

TRUE



FALSE

## Summary

1. BEB charging is a lot more than just plugging in a charger or having a bus drive into the shop to begin charging through the pantograph.
2. Multiple options exist for BEB charging and each comes with its own set of charging standards.
3. Charging maintenance can be straightforward, but you should always keep your guard up as there are many things that could result in danger to you or other around you.
4. Lots of current and existing charging technologies, prototypes and opportunities coming soon